



**BSK ZEPHYR**

**DECENTRALIZED VENTILATION WITH HEAT RECOVERY**

[www.bskhvac.com.tr](http://www.bskhvac.com.tr)



## BSK ZEPHYR DECENTRALIZED HEAT RECOVERY DEVICE

The BSK Zephyr decentralized heat recovery device is an intelligent and connected ventilation solution designed for spaces without traditional ventilation systems. At its heart, the BSK Zephyr features a ceramic heat recuperator paired with a two-way fan. Operating on a 70-second periodic cycle, the device alternates between air intake and exhaustion. During the exhaust phase, it removes stale indoor air while recharging the ceramic core. When the cycle reverses, fresh outdoor air is pushed through the charged core, either heating or cooling it based on the season. With heat exchange rates reaching up to 90%, the BSK Zephyr enables efficient energy recovery. Additionally, it supports wireless communication between multiple devices, integrates seamlessly with a mobile app, and facilitates zoning for customized ventilation control.

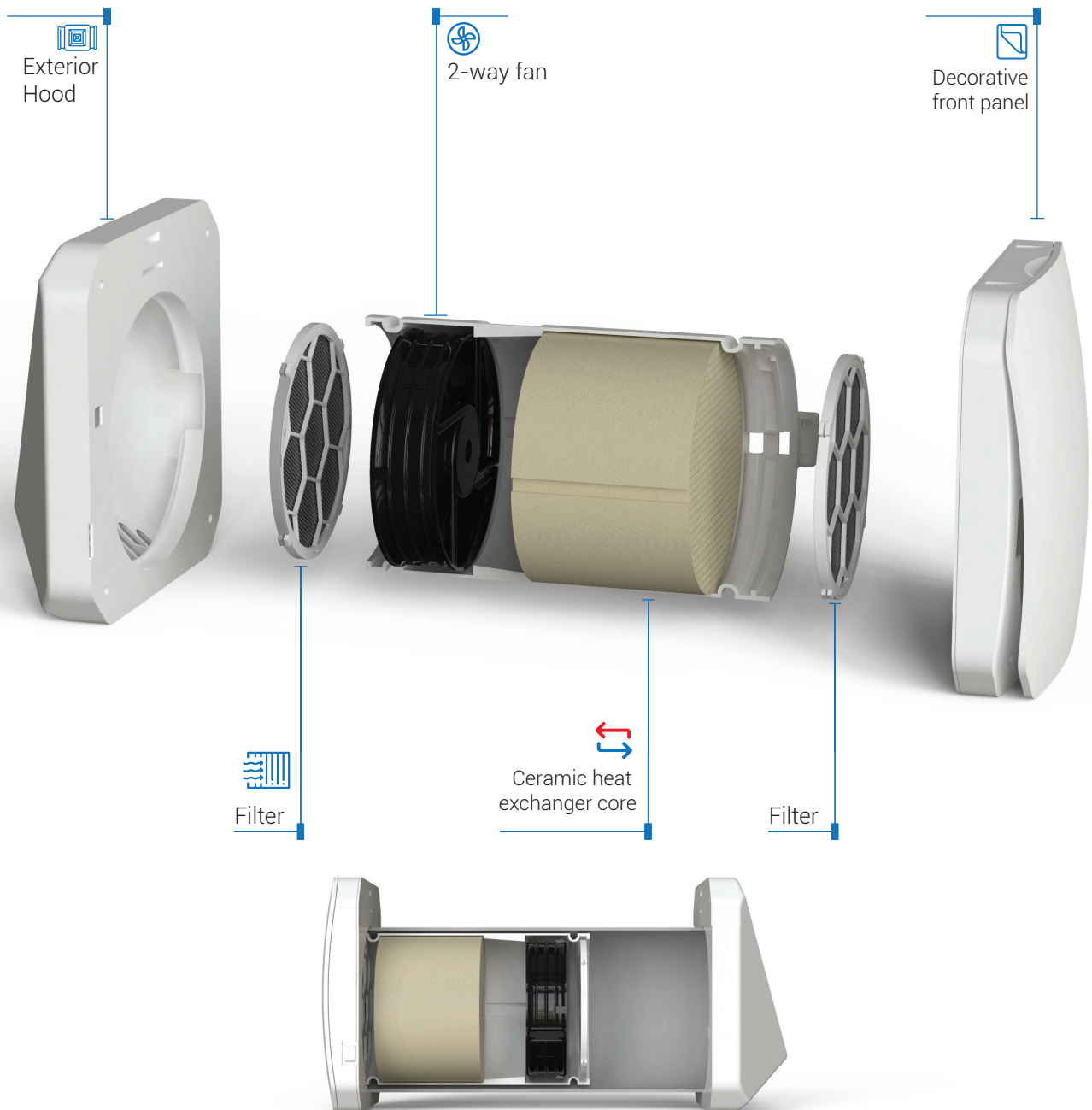
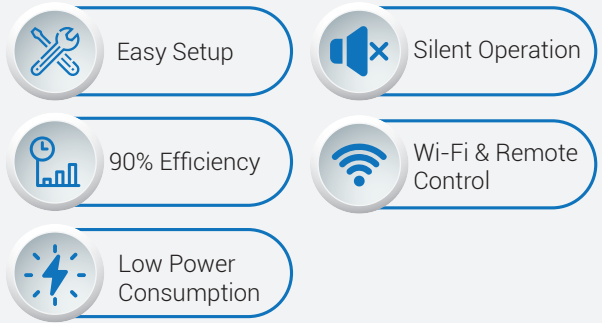

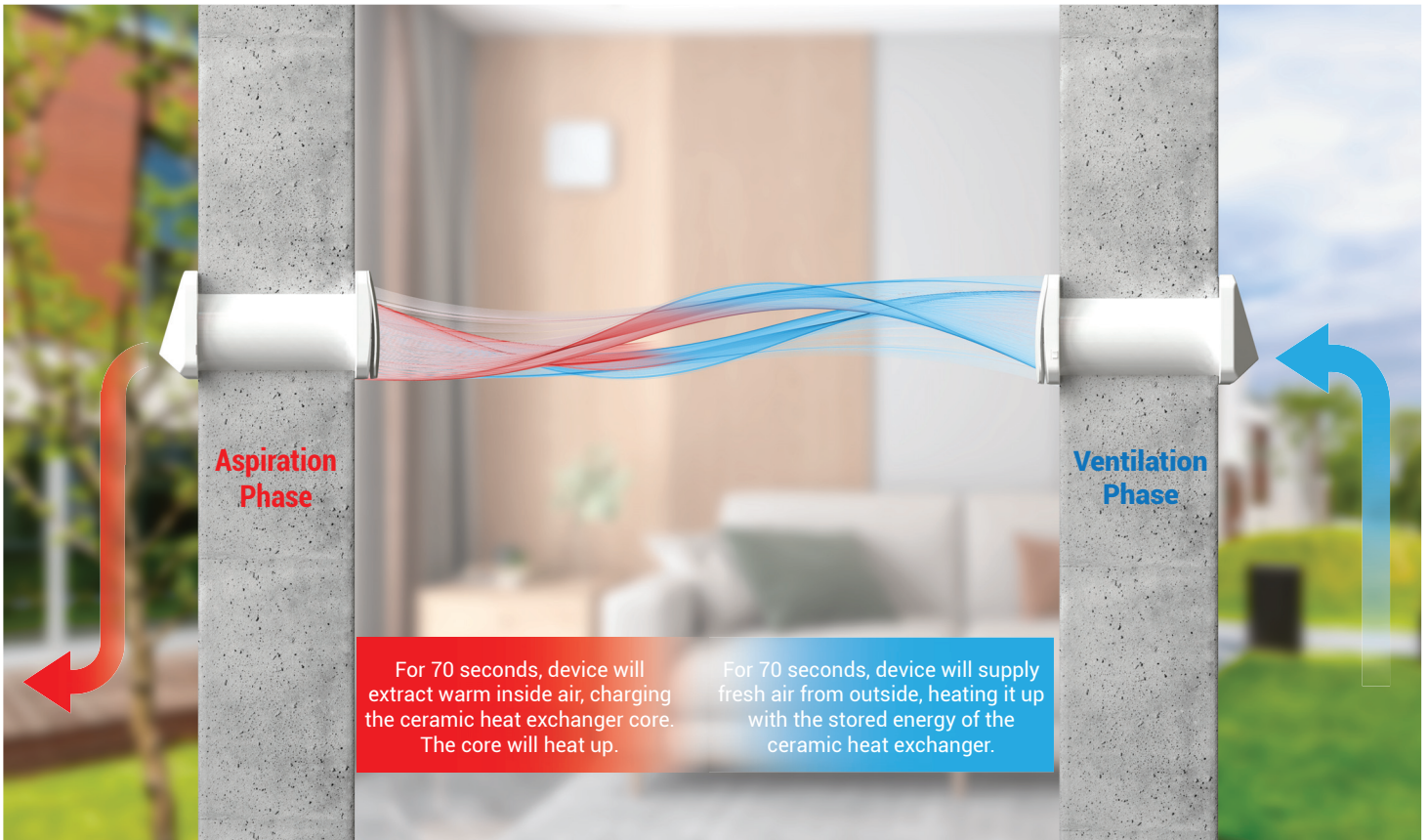

Built-in WiFi chip enables wireless pairing of multiple devices across your house. When paired, devices will run either in parallel or in reverse depending on your setup. When the primary device is in ventilation mode, all parallel devices will also follow, while the reverse devices will be in exhaust mode. This way you can have continuous ventilation and aspiration and create air drafts inside or across rooms to increase the effectiveness of ventilation. You can set different settings and speeds for different rooms and create various ventilation zones.

## TECHNICAL SPECIFICATIONS

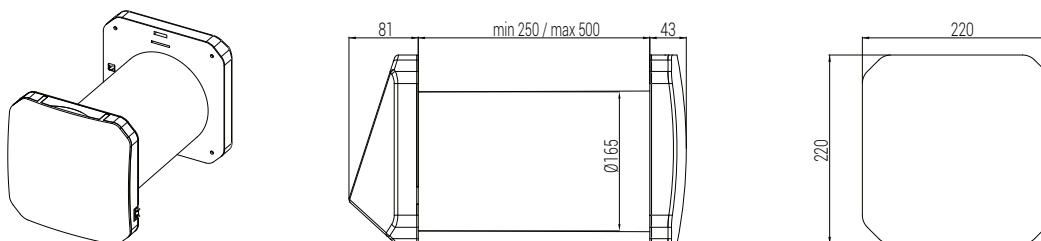

### Technical Specifications

Electrical Connection	110/230V 50/60Hz			
Fan Speed	Night Mode	I	II	III
Air Flow (m <sup>3</sup> /h)	15	30	45	60
Elec. Power (W)	0.9	1.1	2.8	5.9
Sound Power	21.3	25.7	39.8	47.9
Sound Pressure @1m (dBA)	10.3	14.7	28.8	36.9
Sound Pressure @3m (dBA)	0.8	5.1	19.2	27.3
Thermal Efficiency	up to 90%			
Fan Type	2-way EC Controlled 12VDC Axial Fan			
Sensor Type	Temperature and Humidity			
Filter	2x G3 (optional M5)			
Protection Class	IPX4			
Operating Temp.	-25 / +50°C			

## IR REMOTE CONTROL



- Night mode for complete silent operation
- 3 different ventilation modes;
- Intake and Exhaust mode for continuous ventilation or air extraction, and cycle mode for default operation with heat recovery
- Total of 4 fan speeds including Night Mode
- 3 humidity monitoring levels. When a set humidity is reached, the device will enter exhaust mode to dispense excess humidity.

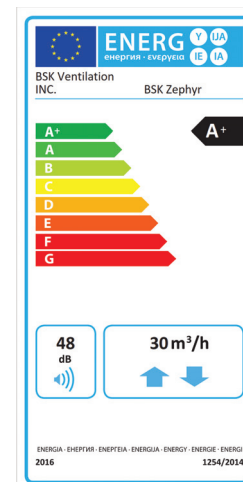

## LOCAL WIRELESS PAIRING OF MULTIPLE UNITS



Wirelessly connect and control multiple BSK Zephyr units through local pairing using the onboard wireless chip. This feature facilitates seamless communication between devices throughout your home. By pairing individual units to a master device, you can establish ventilation zones, ensuring synchronized operation. Plus, manage all connected devices conveniently with a single IR remote. This local connection between devices operates independently of the internet, ensuring reliable functionality without the need for internet access.

## BSK ZEPHYR MOBILE APP

Unlock the full potential of your BSK Zephyr units with our intuitive and powerful BSK Zephyr mobile app. Whether you're at home or on the go, take command of your indoor environment ventilation with convenience.

**Remote Access:** Adjust settings and monitor performance from anywhere with internet access.

**Customized Settings:** Easily manage fan speed, boost settings or humidity levels preferences.

**Weekly Scheduling:** Set up weekly schedules for personalized comfort and energy efficiency.

**Real-Time Monitoring:** Stay informed with instant updates on indoor temperature and humidity conditions.

**Filter Maintenance Alerts:** Receive timely reminders for optimal device performance.

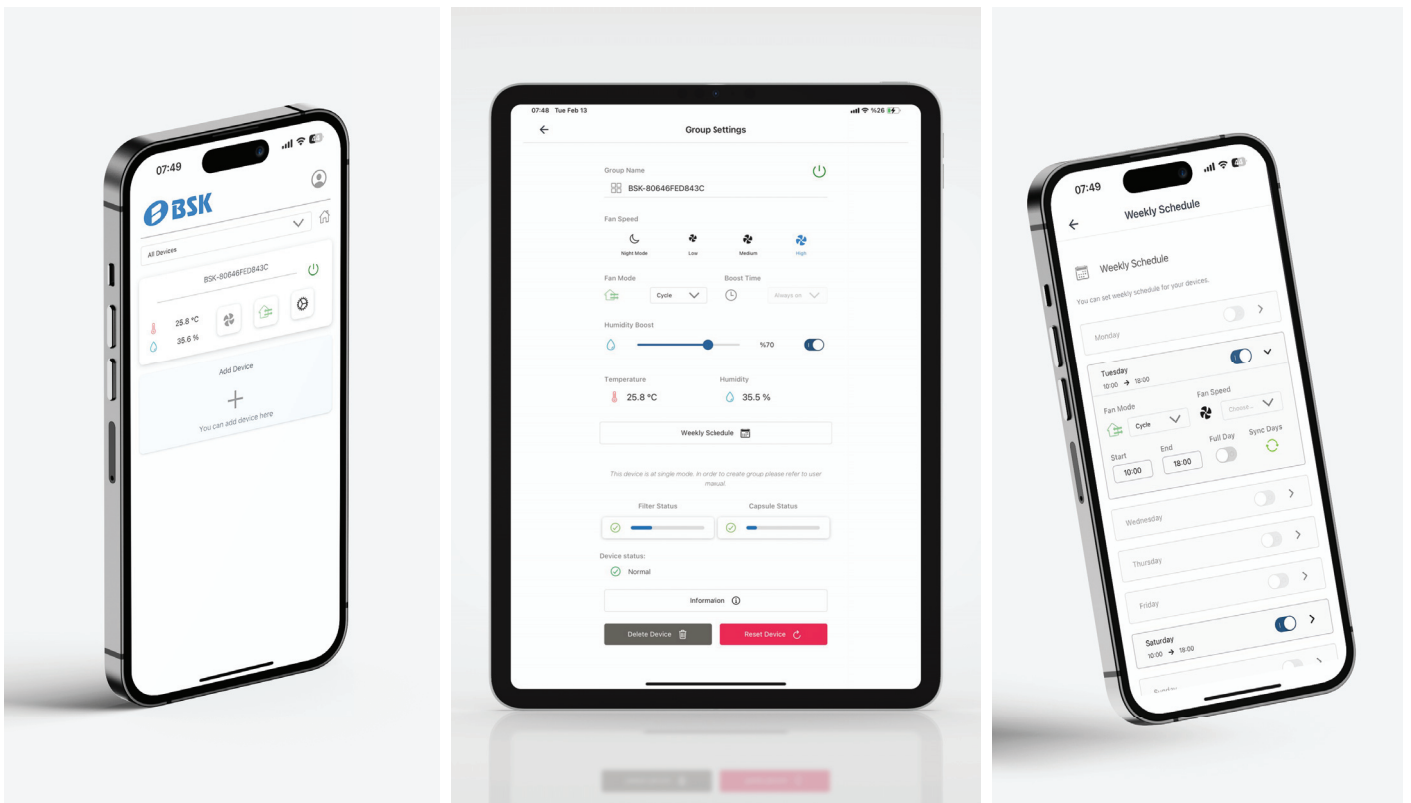

■ Download the app and enjoy the convenience of smart ventilation control at your fingertips.



## DECORATIVE ALUMINUM FRONT PANEL COVERS

- With a variety of shapes and colors available, our products can seamlessly integrate into your home's interior design or stand out as unique artistic statements by themselves.

Zephyr/A/AFP/A

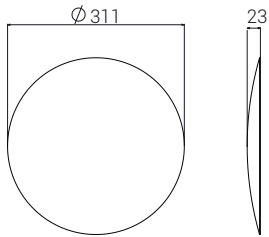

Zephyr/A/AFP/B

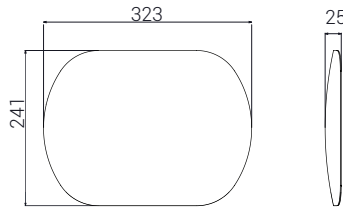

Zephyr/A/AFP/C

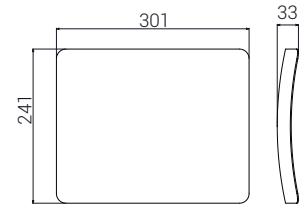

Zephyr/A/AFP/D

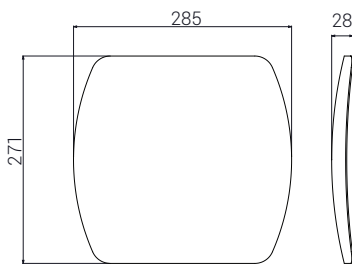

Zephyr/A/AFP/E

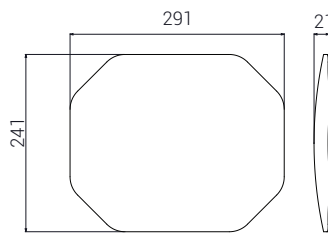

Zephyr/A/AFP/F

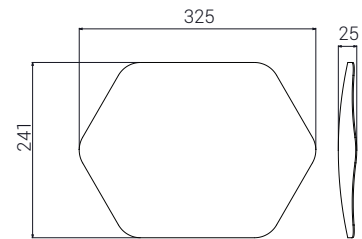

## COLOR PALETTE

- Our products are available in custom colors outside of the standard color palette, with corresponding product codes and pricing adjustments.

DECORATIVE ALUMINUM FRONT PANEL COVERS CODES	DECORATIVE ALUMINUM FRONT PANEL COVERS CODES WITH CUSTOM COLOR
Zephyr/A/AFP/A	Zephyr/A/AFPC/A
Zephyr/A/AFP/B	Zephyr/A/AFPC/B
Zephyr/A/AFP/C	Zephyr/A/AFPC/C
Zephyr/A/AFP/D	Zephyr/A/AFPC/D
Zephyr/A/AFP/E	Zephyr/A/AFPC/E
Zephyr/A/AFP/F	Zephyr/A/AFPC/F

### Standard color palette

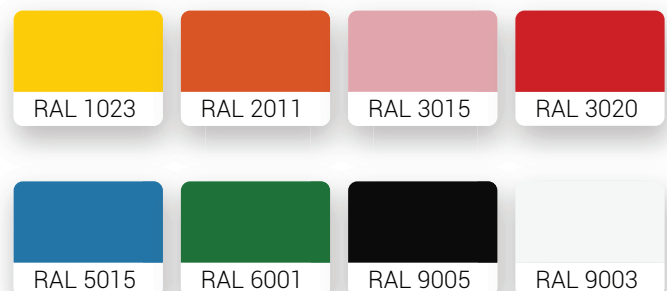

## DECORATIVE METAL EXTERIOR HOOD

- Available in both stainless steel and galvanized options, this durable solution is perfect for enduring challenging outdoor conditions, with a variety of color choices to match your building facade.

Zephyr/A/ PSL

Zephyr/A/SSL

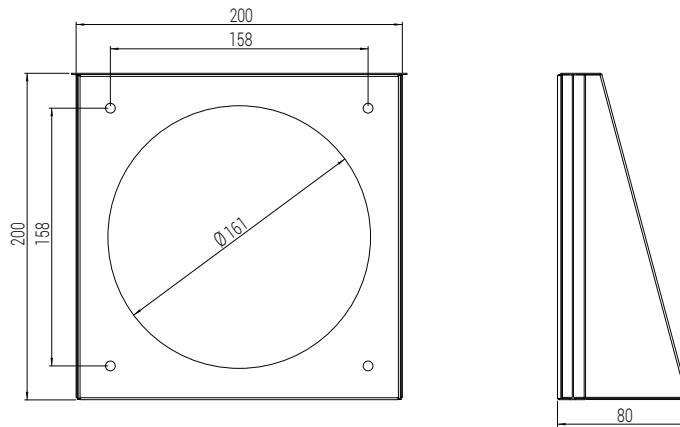
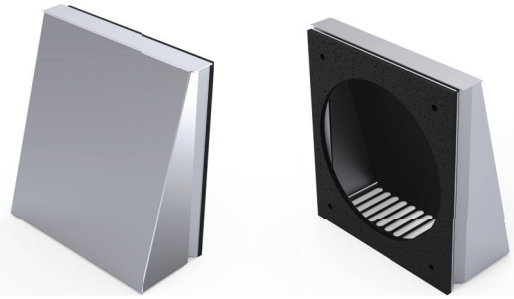

## THE THIN-WALL METAL EXTERIOR HOOD

- The design extends the minimum wall thickness requirement of the Zephyr units to 150mm by accommodating a wider exterior hood. This allows the capsule to extend into the hood, providing greater flexibility in installations with limited wall thickness.

Zephyr/A/SNWL

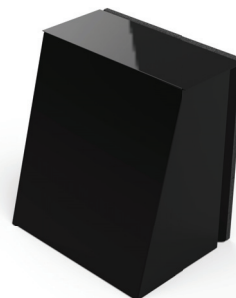
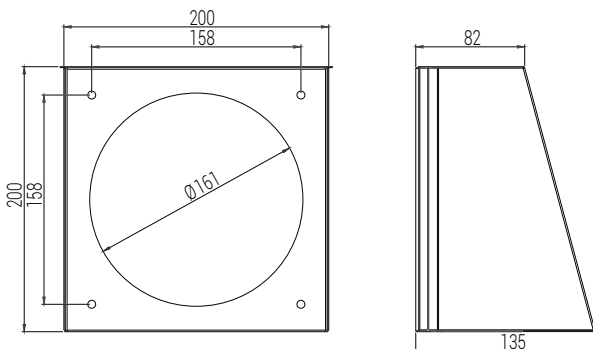



## PRE-CONSTRUCTION EPS BLOCK

- These blocks are specifically designed for use in wall construction, offering effortless integration and unparalleled convenience. The precisely cut hole in each block features a slight slope, eliminating the need for additional slope adjustments during construction.

Zephyr/A/CEB

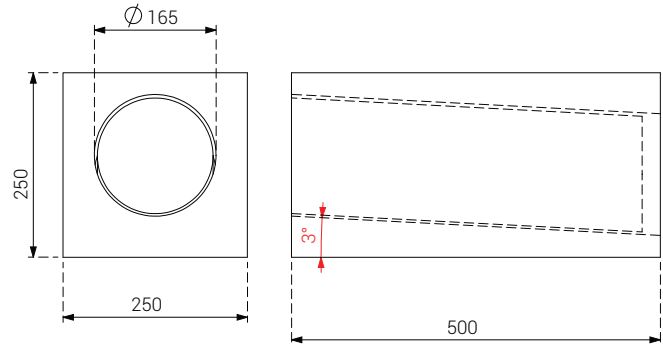
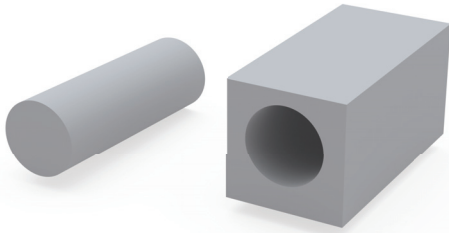

## THE FOLDABLE EXTERIOR LOUVRE

- The installation of the exterior hood can be done from inside the house due to its foldable design, which allows the louvre to fit through the 160mm tubing. This feature is especially beneficial for high-rise buildings, where accessing the exterior wall may be restricted or hazardous.

Zephyr/A/FEL

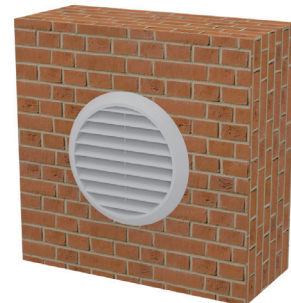
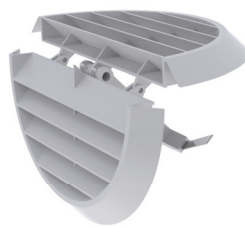
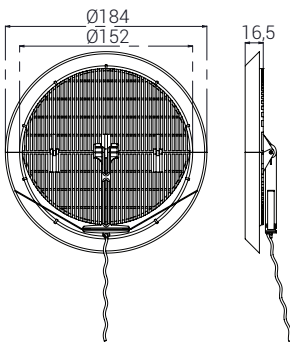

## G3 FILTER

- The unit provides filter options with or without casings. For optimal airflow and noise levels, it is important to replace the filters when notified of maintenance alerts.

Zephyr/A/FC/G

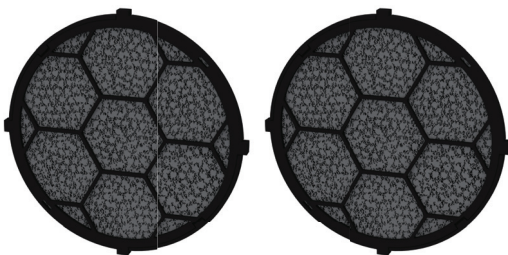

Zephyr/A/F/G

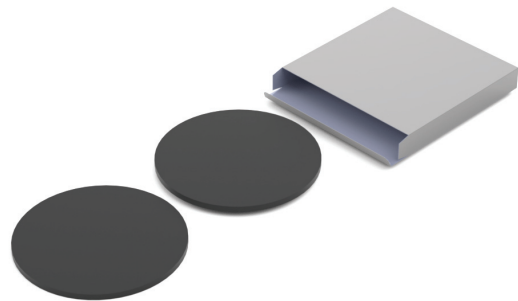

## M5 FILTER

- In areas with high air pollution and pollen levels, you might prefer the M5 filter for better filtration. Initial tests were performed with the G3 filter, so using the M5 filter could affect airflow and noise levels.

Zephyr/A/FC/M

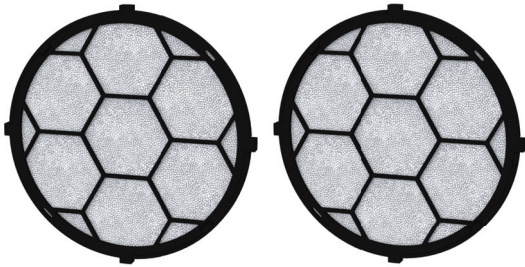

Zephyr/A/F/M

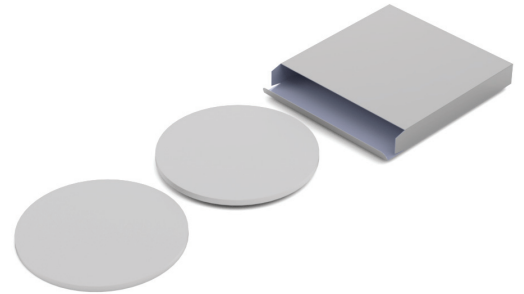

## PRE-CONSTRUCTION WINDOW FACADE EXTENSION

- The pre-construction window facade extension improves your building's appearance with a seamless 90-degree turn into the wall. This innovative solution replaces the plastic outer hood of the unit, allowing for the placement of a slim louvre near a window side wall. With its installable structure, the air outlet direction can be customized to suit your home.

Zephyr/A/CWFE

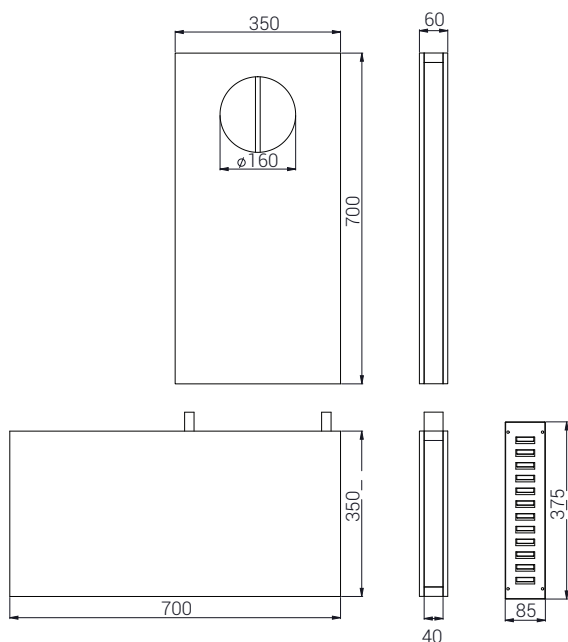



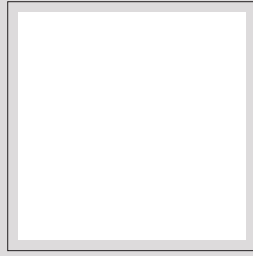

BSK Ventilation Equipment INC.

📍 Mimar Sinan mah. Basra cad. No: 59 / A Sultanbeyli, İstanbul  
☎️ +90 (216) 669 09 70  
🌐 info@bskhavalandirma.com.tr

[www.bskhvac.com.tr](http://www.bskhvac.com.tr)